



链滴

# USB 公头引脚定义

作者: [HaujetZhao](#)

原文链接: <https://ld246.com/article/1621401719577>

来源网站: 链滴

许可协议: [署名-相同方式共享 4.0 国际 \(CC BY-SA 4.0\)](#)

供接线参考。

注意此处是 **公头** 引脚定义!

## USB Type-A:

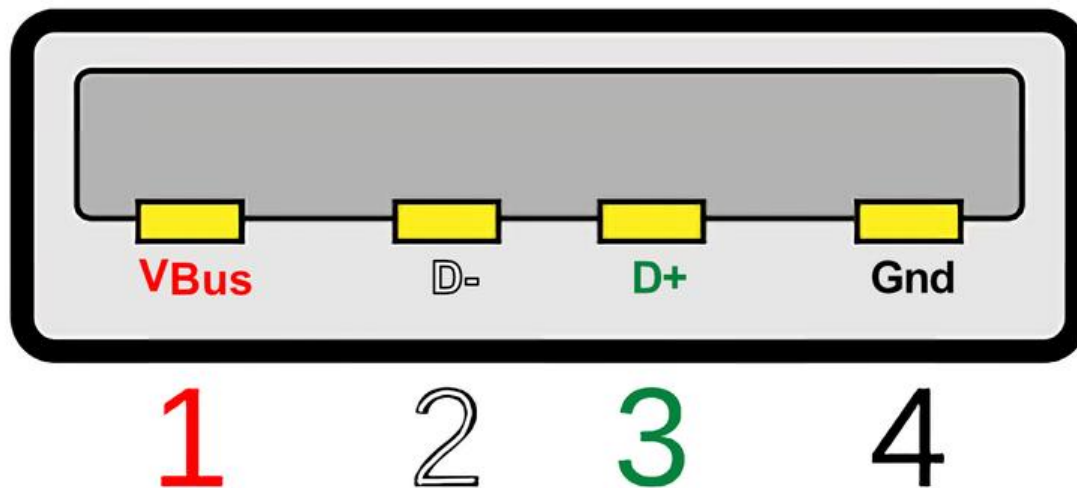

# Type-A

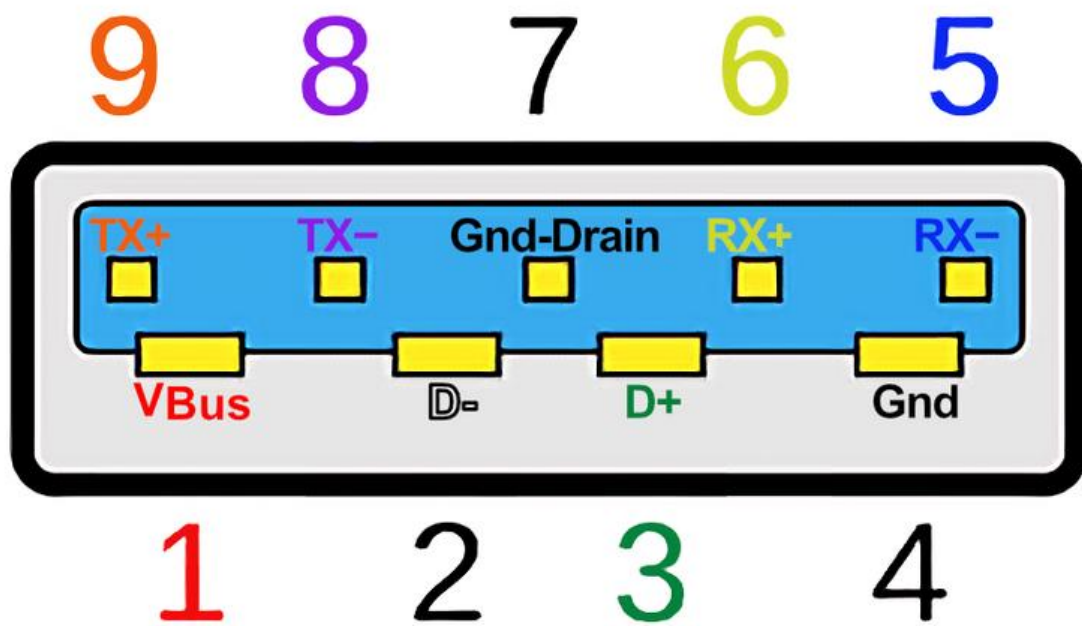

# Type-A SuperSpeed

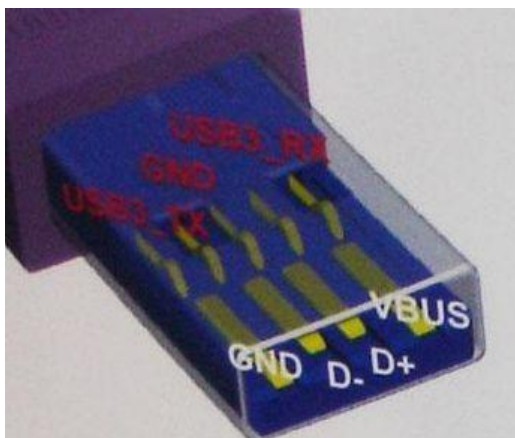

Micro-USB

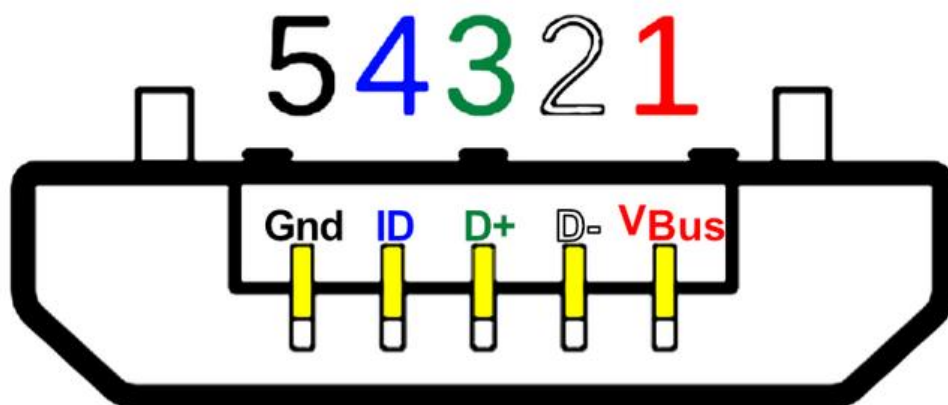

# Micro-B

Mini-USB

1 2 3 4 5

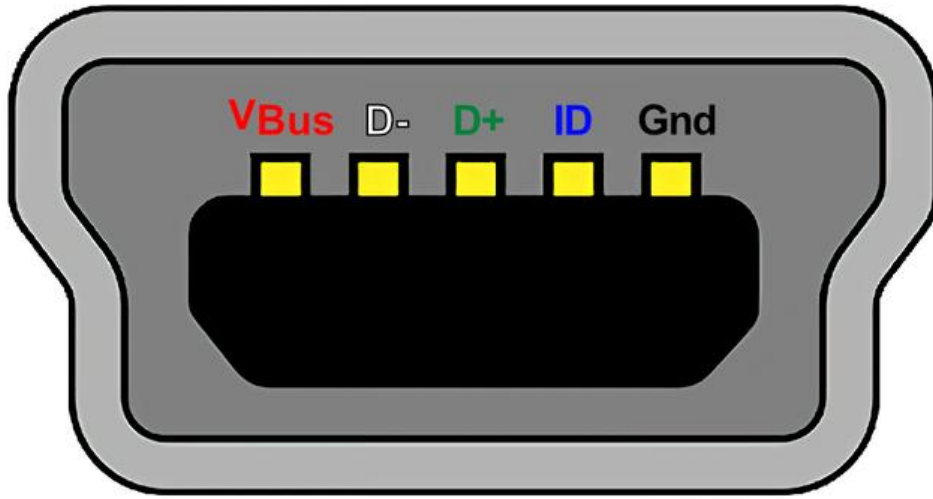

# Mini-B

## Type-C

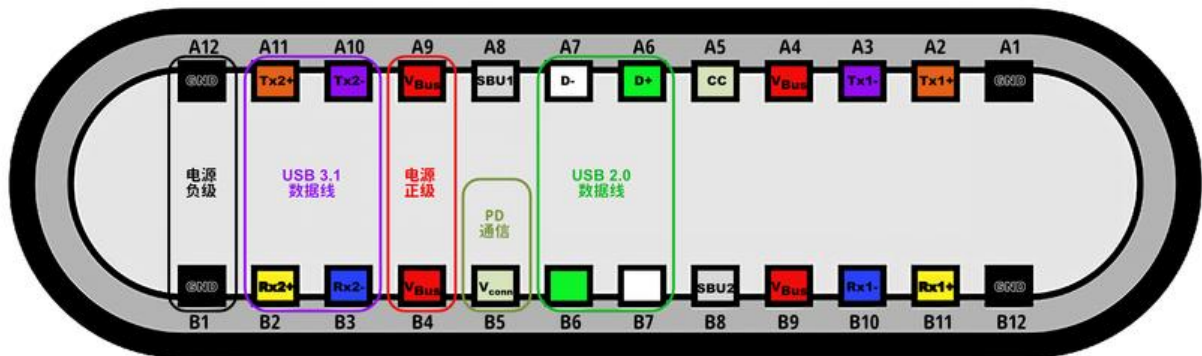



|     |      |      |      |      |    |    |      |      |      |      |     |
|-----|------|------|------|------|----|----|------|------|------|------|-----|
| B12 | B11  | B10  | B9   | B8   | B7 | B6 | B5   | B4   | B3   | B2   | B1  |
| GND | RX1+ | RX1- | VBUS | SBU2 | D- | D+ | CC2  | VBUS | TX2- | TX2+ | GND |
| A1  | A2   | A3   | A4   | A5   | A6 | A7 | A8   | A9   | A10  | A11  | A12 |
| GND | TX1+ | TX1- | VBUS | CC1  | D+ | D- | SBU1 | VBUS | RX2- | RX2+ | GND |

|     |      |      |      |      |    |    |       |      |      |      |     |
|-----|------|------|------|------|----|----|-------|------|------|------|-----|
| 21B | 11B  | B10  | B9   | B8   | 7B | 6B | 5B    | 4B   | 3B   | 2B   | 1B  |
| GND | +RX1 | -RX1 | VBUS | SBU2 |    |    | VCONN | VBUS | -TX1 | +TX1 | GND |
| L1V | 2V   | 3V   | 4V   | 5V   | 9V | 7V | 8V    | 6V   | 01V  | 11V  | 21V |
| GND | TX1+ | TX1- | VBUS | CC   | D+ | D- | SBU1  | VBUS | RX2- | RX2+ | GND |

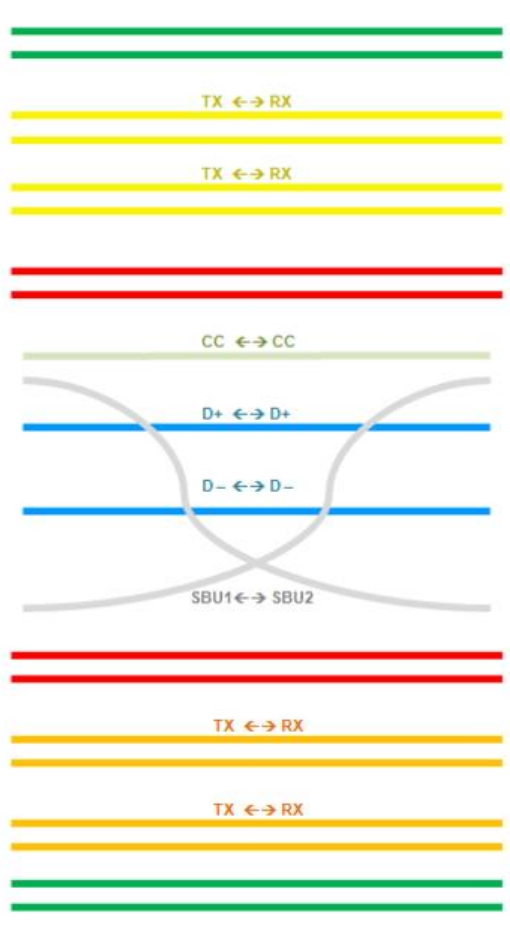

|     |      |      |      |      |    |    |       |      |      |      |     |
|-----|------|------|------|------|----|----|-------|------|------|------|-----|
| 21B | 11B  | B10  | B9   | B8   | 7B | 6B | 5B    | 4B   | 3B   | 2B   | 1B  |
| GND | RX1+ | RX1- | VBUS | SBU2 |    |    | VCONN | VBUS | TX2- | +TX2 | GND |
| L1V | 2V   | 3V   | 4V   | 5V   | 9V | 7V | 8V    | 6V   | 01V  | 11V  | 21V |
| GND | +TX1 | -TX1 | VBUS | CC   | D+ | D- | SBU1  | VBUS | RX2- | +RX2 | GND |

|     |      |      |      |      |    |    |      |      |      |      |     |
|-----|------|------|------|------|----|----|------|------|------|------|-----|
| A1  | A2   | A3   | A4   | A5   | A6 | A7 | A8   | A9   | A10  | A11  | A12 |
| GND | TX1+ | TX1- | VBUS | CC1  | D+ | D- | SBU1 | VBUS | RX2- | RX2+ | GND |
| B12 | B11  | B10  | B9   | B8   | B7 | B6 | B5   | B4   | B3   | B2   | B1  |
| GND | RX1+ | RX1- | VBUS | SBU2 | D- | D+ | CC2  | VBUS | TX2- | TX2+ | GND |

